

**ONE - BEAM - 35B1**  
(ANGLE 3 1/2 LEG WELDED WITH BEAM)

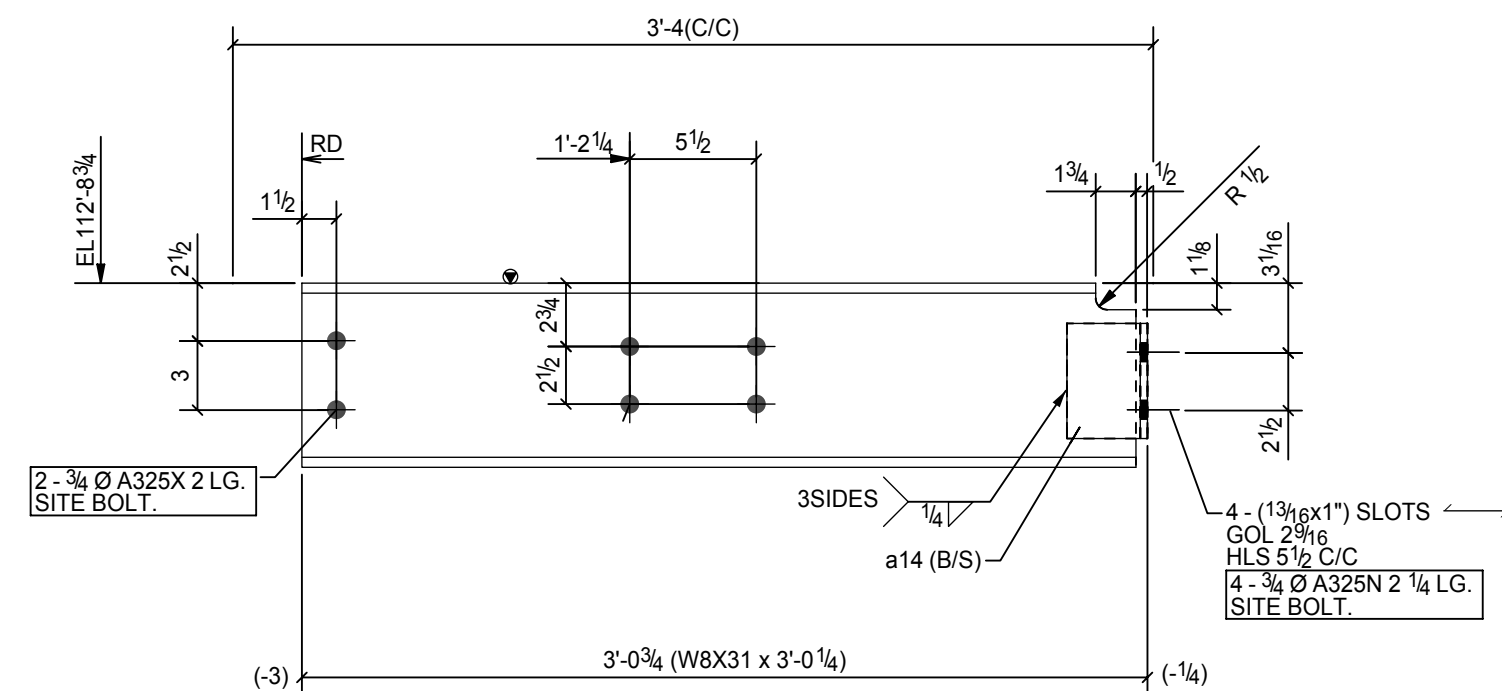

**ONE - BEAM - 35B2**  
(ANGLE 3 1/2 LEG WELDED WITH BEAM)

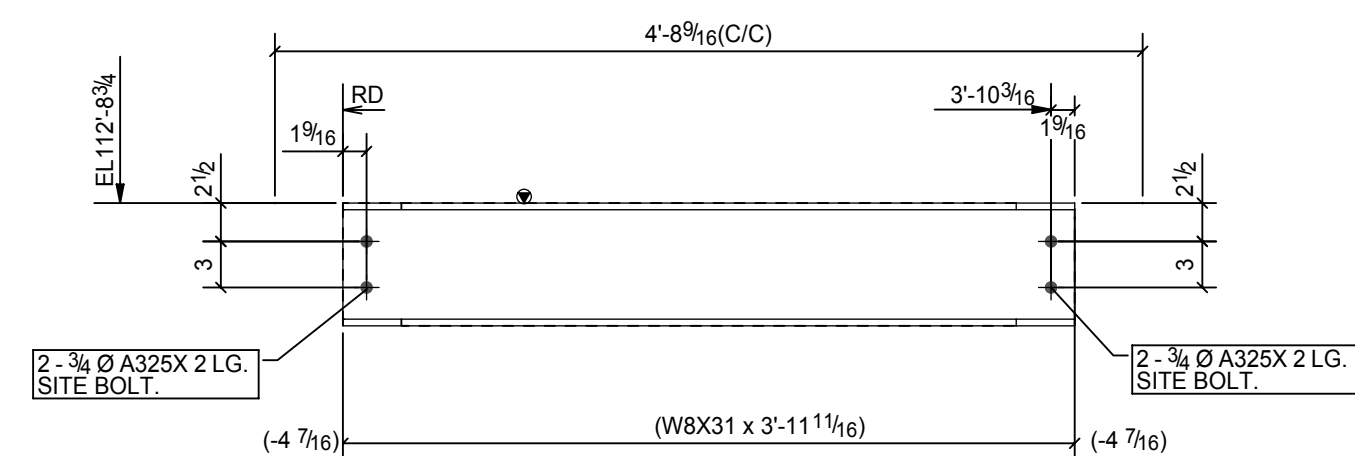
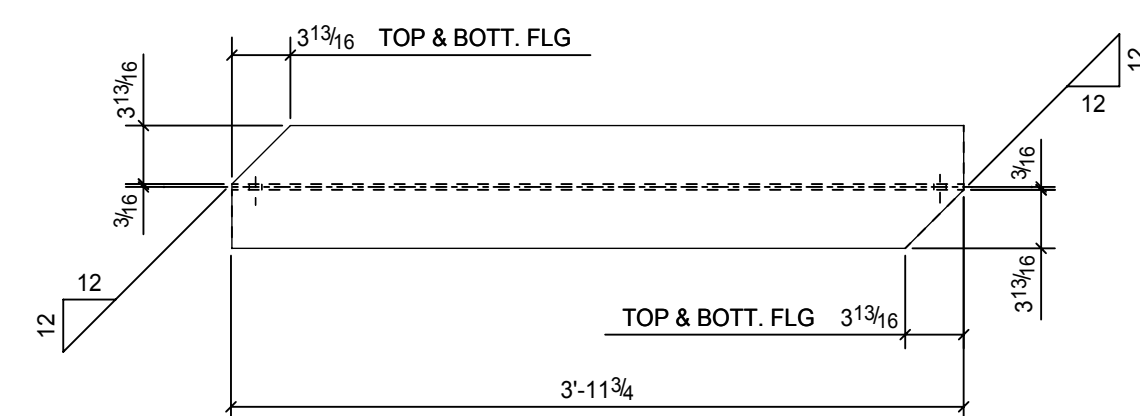

**2 - BEAMS - 35B3**

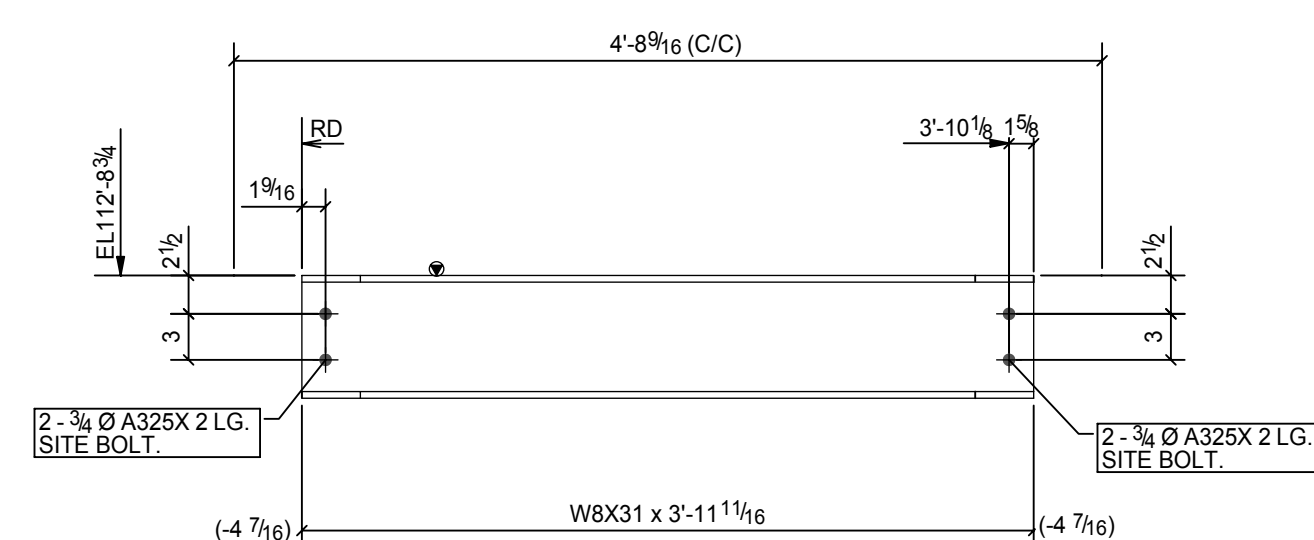
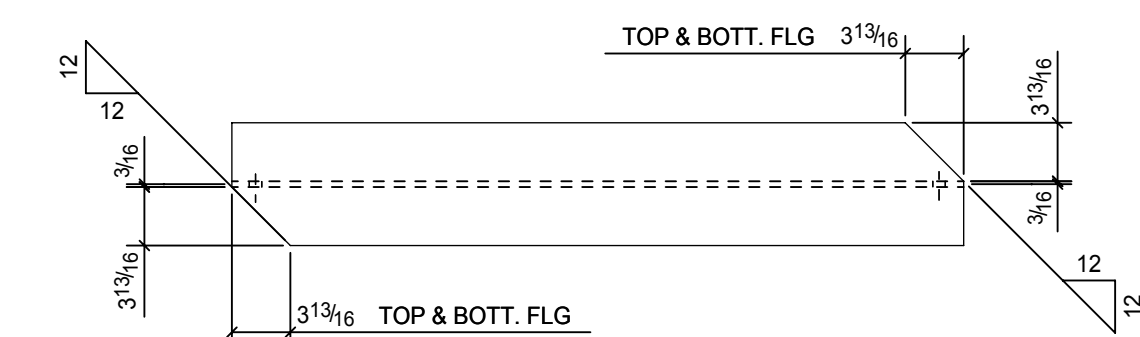

**ONE - BEAM - 35B4**

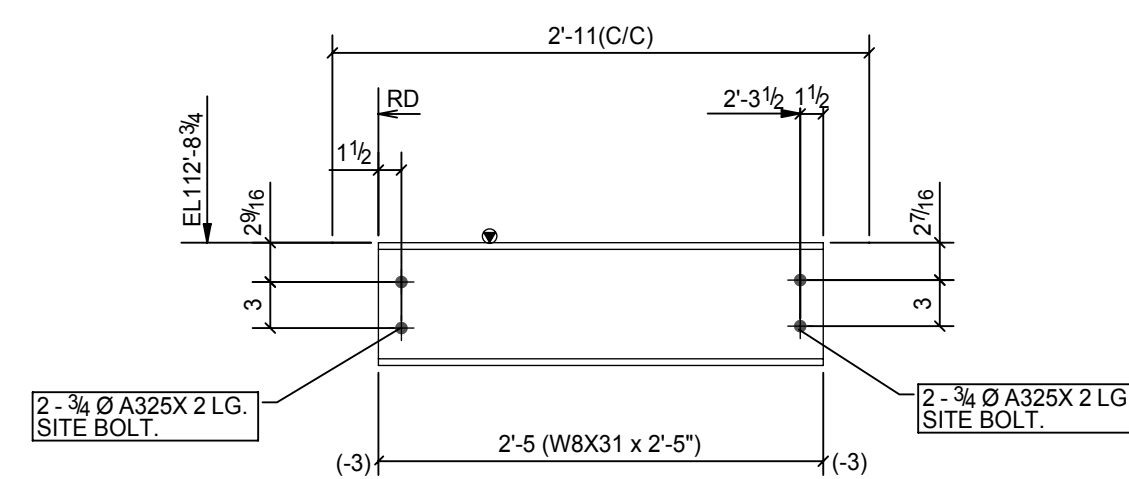

**2 - BEAMS - 35B5**

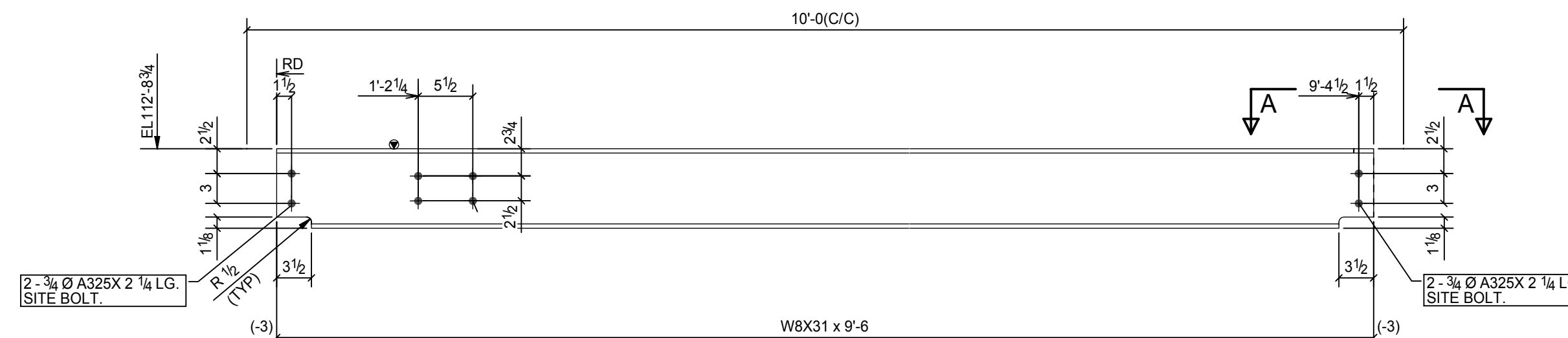
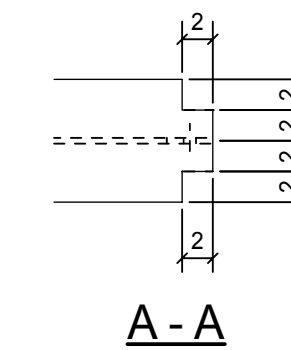

**ONE - BEAM - 35B6**

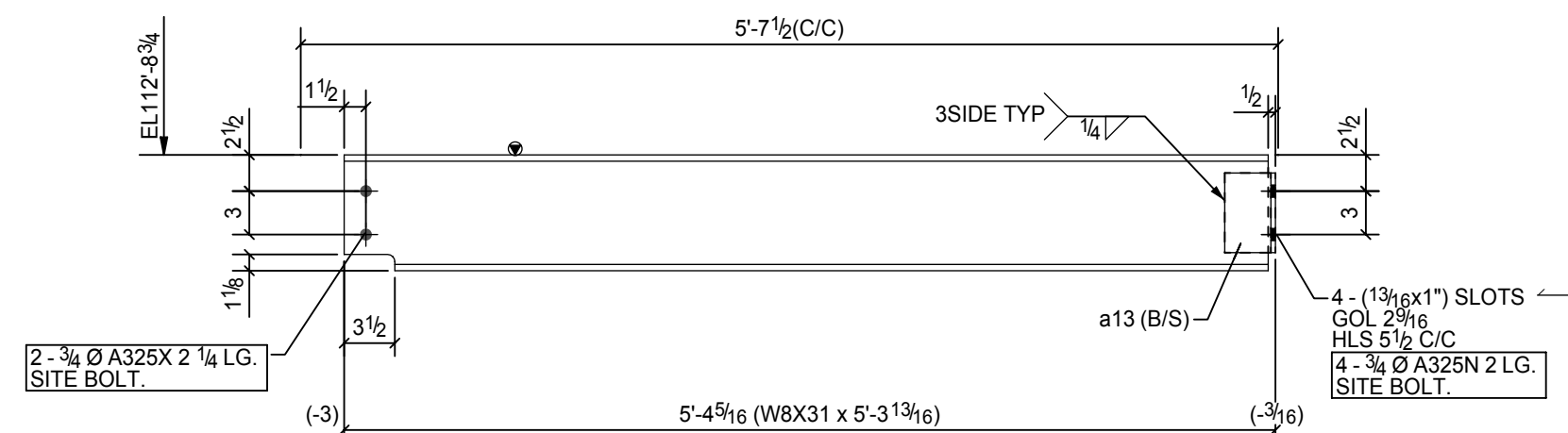

**2 - BEAMS - 35B7**  
(ANGLE 3 1/2 LEG WELDED WITH BEAM)

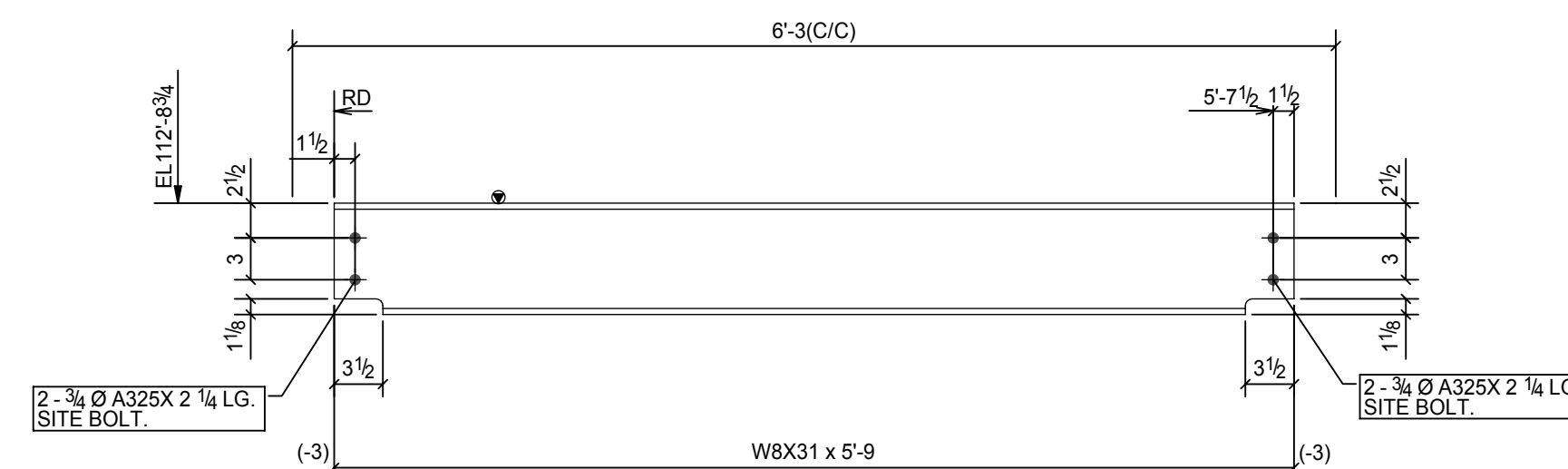

**2 - BEAMS - 35B8**

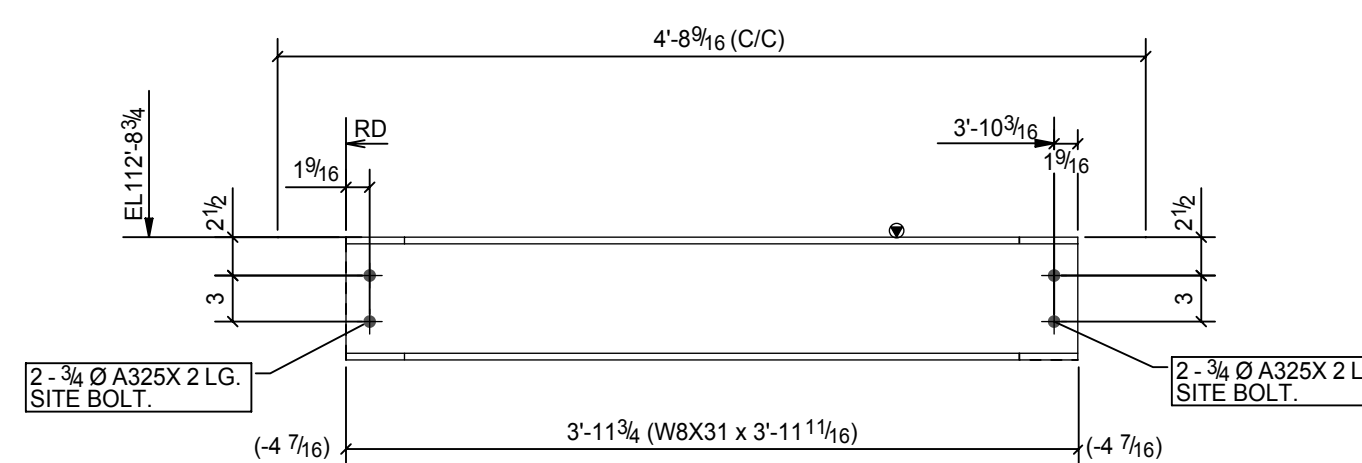
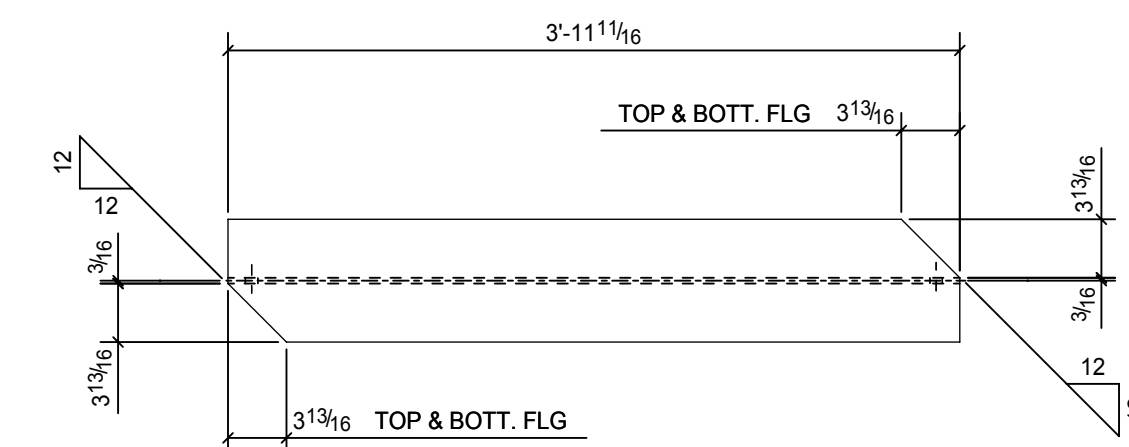

**ONE - BEAM - 35B9**

SEQ.				BILL OF MATERIAL						
A	B	C	D	SHIP MARK	PIECE MARK	QTY.	DESCRIPTION	LENGTH	GRADE	REMARKS
1	0	0	0	35B1		1	W8X31	9'-5 5/8"	A992	NO PAINT
					a106	2	L4X3-1/2X5/16	0'-5"	A36	
					a106	2	L4X3-1/2X5/16	0'-5"	A36	
1	0	0	0	35B2		1	W8X31	3'-0 1/4"	A992	NO PAINT
					a14	2	L4X3-1/2X5/16	0'-5"	A36	
2	0	0	0	35B3		2	W8X31	3'-11 11/16"	A992	NO PAINT
1	0	0	0	35B4		1	W8X31	3'-11 11/16"	A992	NO PAINT
2	0	0	0	35B5		2	W8X31	2'-5"	A992	NO PAINT
1	0	0	0	35B6		1	W8X31	9'-6"	A992	NO PAINT
2	0	0	0	35B7		2	W8X31	5'-3 13/16"	A992	NO PAINT
					a13		L4X3-1/2X5/16	0'-5 1/2"	A36	
2	0	0	0	35B8		2	W8X31	5'-9"	A992	NO PAINT
1	0	0	0	35B9		1	W8X31	3'-11 11/16"	A992	NO PAINT

NOTE :

1. NO PAINT

SHOP NOTES

- 1) ALL HOLES 13/16 Dia U.N.O.
- 2) E70XX ELECTRODES
- 3) MATERIAL A36 UNO

REV.	DATE	DESCRIPTION
B		ISSUED FOR FABRICATION
A		ISSUED FOR APPROVAL

Detailer **D & A TECHNICAL SERVICES, INC.**  
LAUREL, MARYLAND PH: 3012725593 FAX: 2402355302

ISSUED For	Date	Ref. Dwg.	E1 & E2	Dwg. Description
APPROVAL		Project :		BEAM DETAILS
FABRICATION		Location :		
		Customer :		
		Arch :		
		Detailed By :		
		Checked By :		
			Job No.	Dwg. No.
				Rev.